

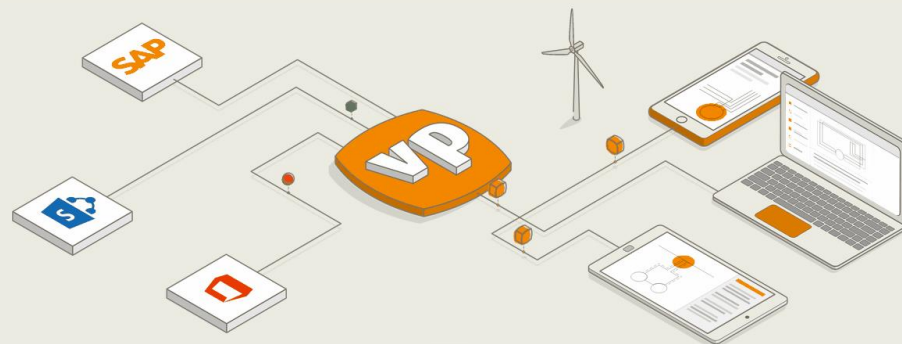

Viewpoint.ai

EPSC Digitalization Digital Transformation in Isolation Management

Sensible Asset Information for
Man, Machine... and specifically Mario



Information Silos

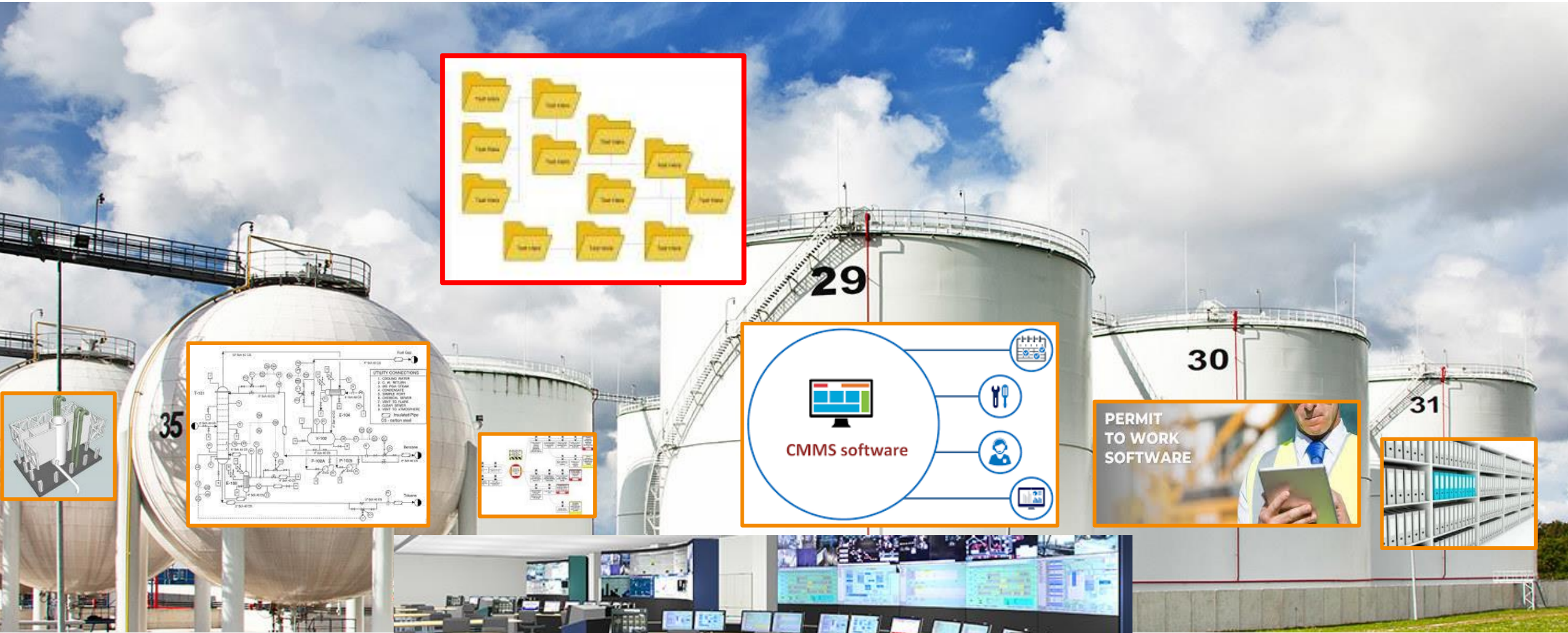



This is Mario

His work preparation is a pain

- On average Knowledge Workers spend 15%-35% of their time searching for information (IDC Study)
- Millennials take 4,5 times longer to find information in existing systems than boomers (HBR study)
- An engineer is losing 9% time switching between applications (HBR study)

He is also unsure of isolation planning quality

- Rework is between 5-10% of project costs.
- 60% of rework could be avoided if EPC had up-to-date existing asset information



Cost of not finding information

- **Job Satisfaction**

Highly trained knowledge workers wasting time on searching

- **Plant Safety**

What can go wrong when performing an isolation using wrong information?

- **Financial Risk**

Use case from BP in 2008 with 100 knowledge workers (@ 80K USD/y)

- **Not finding information: 6 Million USD/Y**

Cost of time spend Looking for and not finding information (not including rework or lost opportunity costs)

- **Rework: 12 Million USD/Y**

Cost of time spend reworking for information not found (15% of time spend in duplicating existing information)

- **Overall: 27 Million USD/Y**

Recent study revealed this increase to for a 900 FTE facility.

Source: <https://www.slideshare.net/escrimshaw/cost-of-not-finding-information-slideshare>



What if Mario becomes Super Mario?

- Read ALL information from all relevant sources
- Create a smart asset model of this information
- Super-charge Work Preparation :
 - Give me all relevant document for Production Cooler B650
 - Give me all related certificates, manuals and drawings
 - Any conflicts with other scheduled work orders?
- Super-charge Isolation Management
 - Verify shutdown procedure for correct assets
 - Do I have the correct assets listed in my isolation procedure?
- Continuously scan for updates in source data
- Be assured of sensible asset information, always!





Viewport.ai

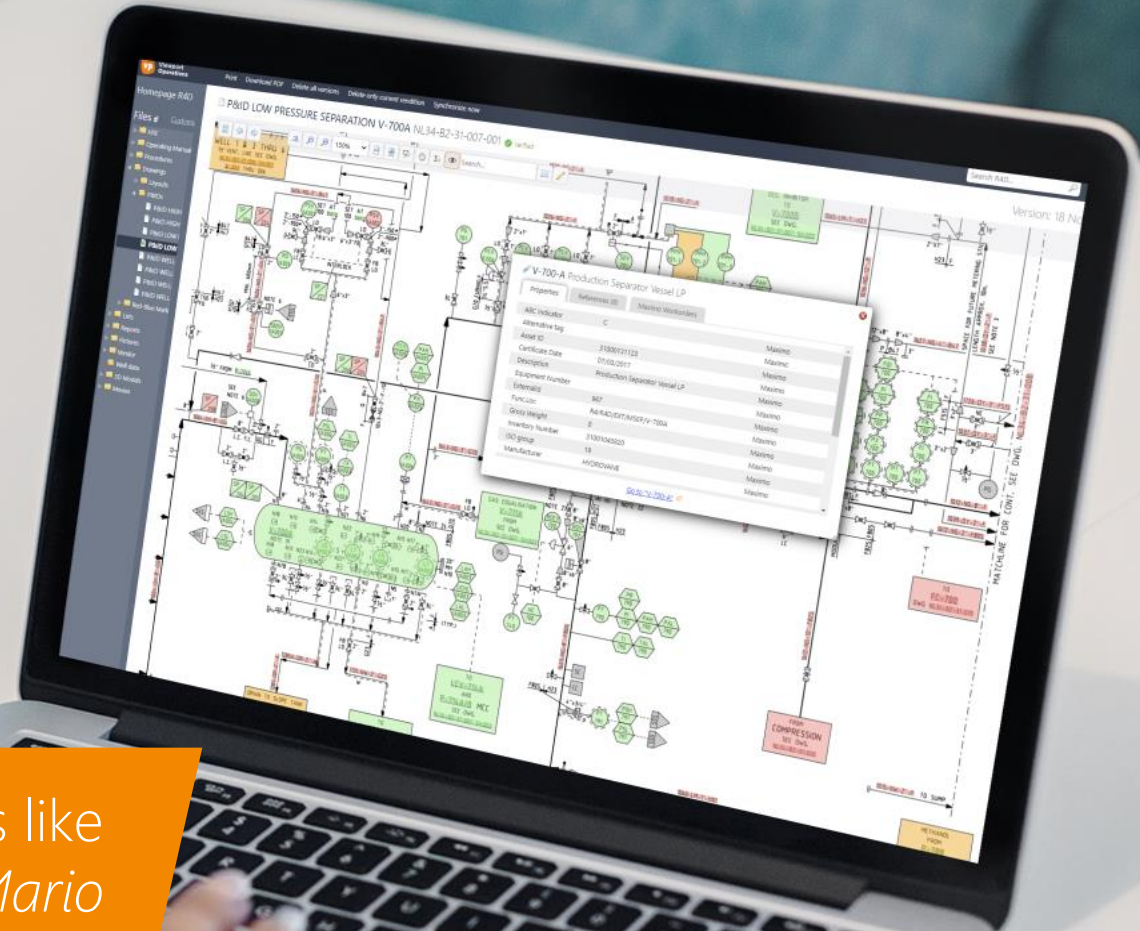

This is what working with Asset Information is like with *Viewport.ai*, turning Mario into *Super Mario*

Sensible Asset Information for Man and Machine

Radial SG believes reliable and accessible information empowers operators, engineers and managers. With Viewport.ai we automatically combine data from existing systems and show the results in context. This enables informed decisions and continuous improvement of information quality



Compliance

Be assured your plants are compliant and control mechanisms are in place



Productivity

Increase productivity with easily accessible information of known quality.



Safety

Be in control of your safety critical data by keeping it up-to-date, complete and consistent



Viewpoint.ai

Industry Leaders using Viewport



Global Partner Network



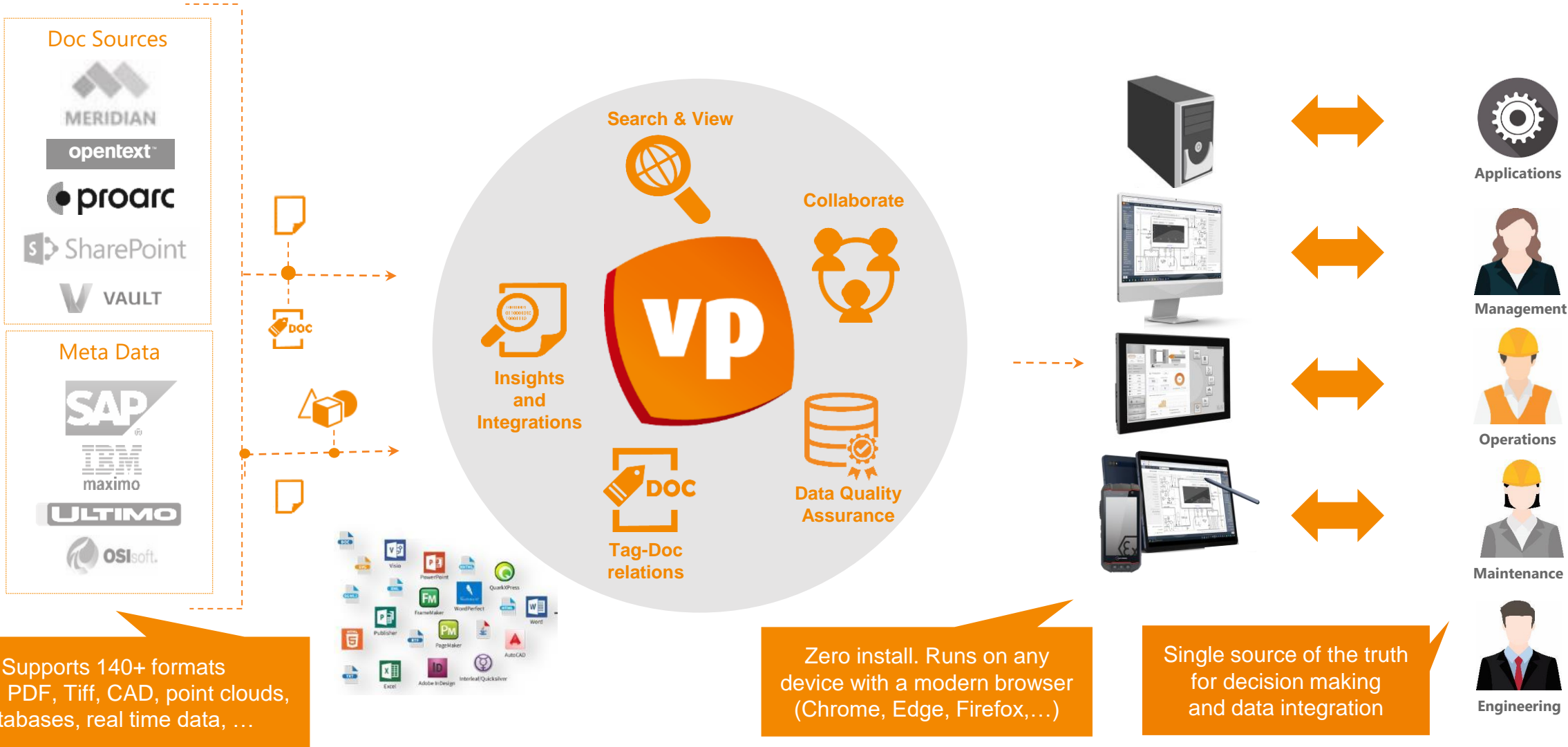

Viewport: Your Single Source of Information



Connected systems

- Asset list**
Last activity: 31 Jul 2023 12:09
Last import: 31 Jul 2023 12:09
- FileSystem**
Last activity: 13 Sep 2023 19:01
- Meridian**
As Built documents
Last activity: 13 Sep 2023 17:01
Last import: 7 Jul 2022 18:21
- SAP**
Last activity: 6 Jul 2022 15:06
Last import: 6 Jul 2022 15:06
- SharePoint R4D**
Last activity: today 16:23
- Ultimo**
Last activity: 13 Sep 2023 19:02
Last import: 13 Sep 2023 19:02
- Wikipedia**
Last activity: 21 June 2022 10:14

Sites List view | [Map view](#)

	Energy R4D Production Unit, including PI data	137 files and pages, 645 tags Last update: today 16:23
	Water Authority WDDO - Beilen	906 files and pages, 555 tags Last update: 7 Jul 2022 18:21
	CO2 Storage Peterhead Carbon Capture Storage (PCCS)	65 files and pages, 126 tags Last update: 6 Jul 2022 19:45
	Wind Farm	48 files and pages, 7808 tags Last update: 7 Jul 2022 17:57
	GIS Information	8 files and pages, 3 tags Last update: 18 Jan 2023 22:17
	FPSO	1122 files and pages, 438 tags Last update: 13 Apr 2023 16:45
	Standards ISO, NOGEP, PGS	261 files and pages, 0 tags Last update: 7 Jul 2022 10:00

News

13 Jul 2023 11:32
Verdantix names Viewport.ai Unique.
Joe Lemming from Verdantix was a guest speaker at our Innovation Day event in Amsterdam earlier this year. Following this event, he has written up the following cool blog post about Viewport:
<https://www.verdantix.com/insights/blogs/s-asset-information-management-system-deploys-unique-data-discoverability-tools-for-industrial-firms> According to Verdantix, "(...) Viewport is unique in how it streamlines information access through an interface familiar to industrial engineers". Furthermore, Verdantix acknowledged our integration with Yokogawa RAP, emphasizing how it improves the safety and efficiency of permitting and isolation management processes.

6 Jul 2021 17:31
Viewport 5.3
A new look and feel, handy shortcuts, improved reports and tools... Viewport 5.3 helps you work more productively!

3 Nov 2020 14:56
Viewport connects

- Document management systems, document stores like SharePoint
- Asset registers such as Maintenance management systems

Nuclear Power Plant – Operational Management

1.400+
P&ID's

500.000+
tagged items

4000+
active work orders

100
active users daily

>10
man years saved

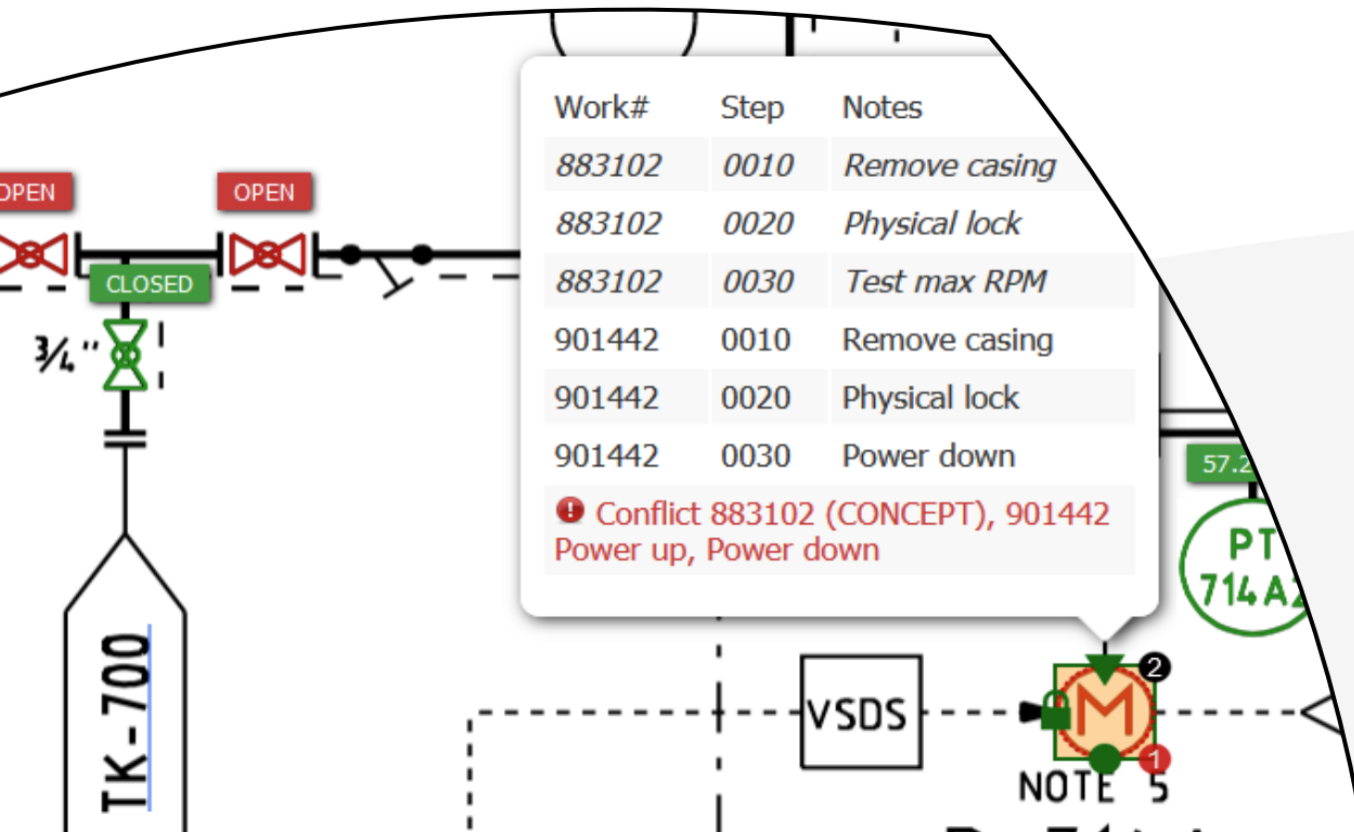

"Our partners' extensive knowledge and understanding of the industry, and their ability to translate this to a working solution based on Viewport, were key factors in making this project a success."

*Bart Struyven,
Shift Manager Doel 4*

Nuclear Power plant – Viewport integration

The image shows a P&ID diagram of a nuclear power plant system. A specific flow valve, labeled 'FAC4/VALV-699', is highlighted with a green box and a purple circle containing the number '2'. A data popup window is overlaid on the diagram, providing detailed information about this valve. The popup includes tabs for 'PI data (1)', 'Work order items (2)', 'Properties', and 'References (8)'. The 'PI Data (1)' tab is active, showing a table with columns for 'PI Tag', 'PI Value', and 'Timestamp'. The 'Work order items' section is also active, displaying a table with columns for 'Work order', 'Step', 'Floc', 'Link', 'Status', 'Lock Tag', and 'Untag'. A legend icon with a purple square and a '2' is visible in the popup, and a 'Go to' link is provided at the bottom.

FAC4/VALV-699 Flow valve to secondary storage (FAC4-V600)

PI data (1) | Work order items (2) | Properties | References (8)

PI Data (1)

PI Tag	PI Value	Timestamp
F4VV0699.PV	Open	4-11-2020 01:01:35

Active work order items

Work order	Step	Floc	Link	Status	Lock Tag	Untag
871834	140	F VALV-699/ACT	Command	Tagged	Close	Open
871842	140	F VALV-699/ACT	Command	Printed	Close	Open

[Go to "PKD-D4/SC-VV0617"](#)

Legend

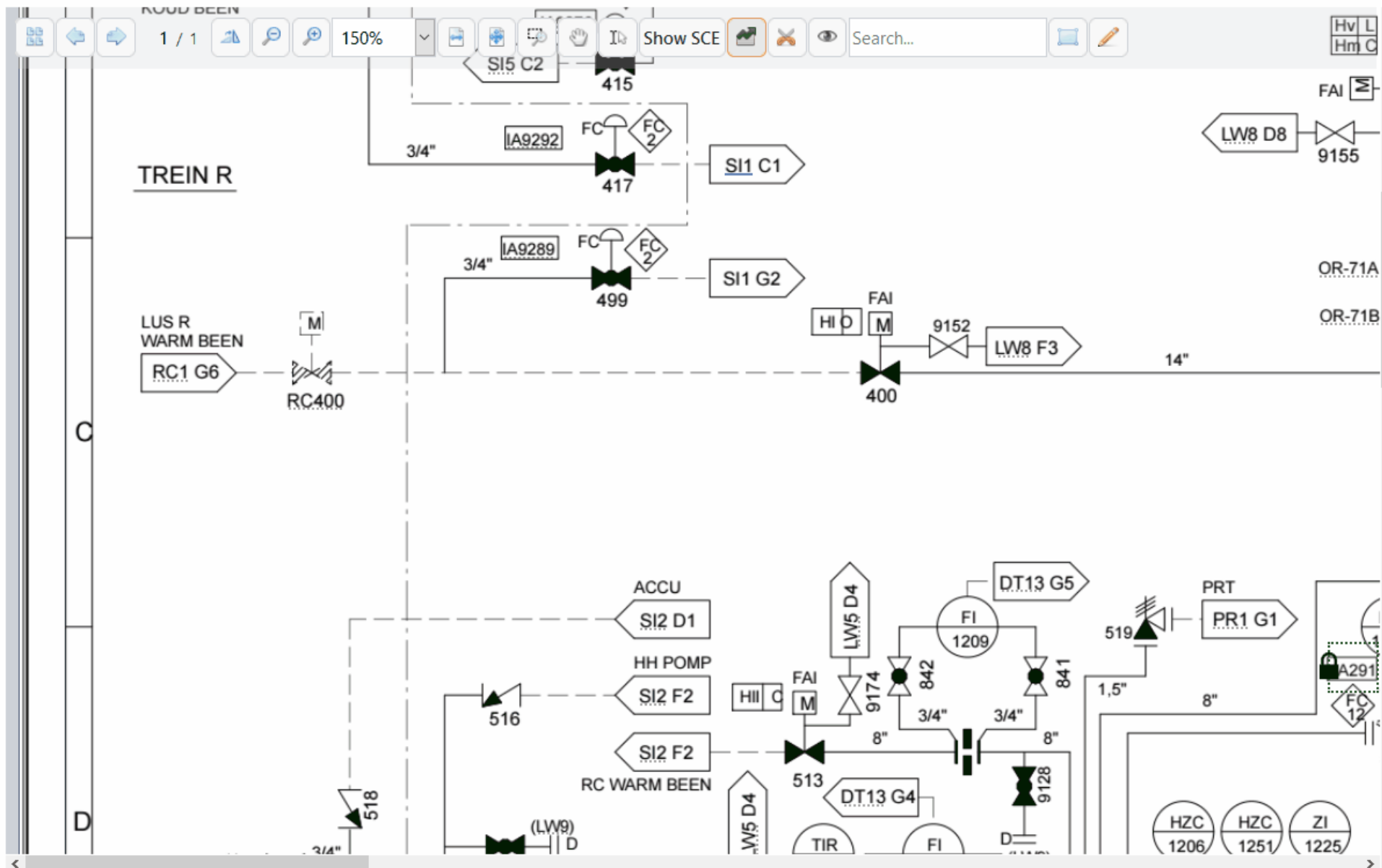

Possible references (115)

Markup (0)

QC (255/840)

Layers (7 / 0)

VSI

Yokogawa integrations



Number ↕	Location ↕	Type ↕	Name ↕	Reference ↕	Equipment Name ↕	Created ↕	Last Modified ↕	Status ↕	* Start Date ↕	* End Date ↕	Non Conformance ↕
22 records Hide filter bar ⚙️											
821	SysRoot	Isolation	Electrical lockout		DBA-3L1	06/07/2022 11:31	06/07/2022 12:17	● Complete	06/07/2022	07/07/2022	?
839	SysRoot	Isolation	Test_CS_HW_Isolation		Confined Space	20/07/2022 15:42	20/07/2022 15:42	● Definition	20/07/2022	21/07/2022	?
860	SysRoot	Isolation	Isolate Transfer Pipes from DA1 to DA2		DA Transfer	05/08/2022 15:55	05/08/2022 16:30	● Isolated	05/08/2022	06/08/2022	?
1054	SysRoot	Isolation	CB1 Isolation example		Coil Box	12/12/2022 12:25	12/12/2022 13:06	● Definition	14/01/2022	15/01/2022	?
1055	SysRoot	Isolation	CB1 All in one		Coil Box	12/12/2022 12:57	13/03/2023 11:51	● Definition	14/01/2022	15/01/2022	?
1434	SysRoot	Isolation	Example for Serica 080823		V-700-A	08/08/2023 11:04	29/08/2023 13:52	● Complete	08/08/2023	09/08/2023	?
1435	SysRoot	Isolation	Example 2		V-700-A	08/08/2023 11:28	26/09/2023 12:08	● Definition	08/08/2023	09/08/2023	?
1436	SysRoot	Isolation	Isolation test VP		Coil Box	29/08/2023 13:54	29/08/2023 13:54	● Ready	29/08/2023	29/08/2023	?
1437	SysRoot	Isolation	Test VP		Coil Box	29/08/2023 13:56	29/08/2023 13:56	● Ready	29/08/2023	29/08/2023	?

Refinery Benefits

PRODUCTIVITY

- ✓ Creating **foundation** for digital twin, AI/ML models and other next gen apps.
- ✓ 360 degree view better **insights** and faster **decisions**
- ✓ Increased **effectivity** of operators, engineers and their managers
- ✓ Creating nonintrusive vendor agnostic **information portal**

SAFETY

- ✓ Providing dynamic HSEQ checklists for missing or inconsistent information
- ✓ Minimize downtime, Maximize **safe production** time
- ✓ Reduce **risk** by increasing situational awareness
- ✓ Integrate **barrier** and **risk management** models with operational information
- ✓ Ensure up-to-date **work instructions** and procedures are available and used

COMPLIANCE

- ✓ **Audit** readiness
- ✓ Direct insight in information critical for "**License to Operate**"

Viewport.ai Delivers A Knowledge Management System With Rich Integrations For European Energy Firms

By Joe Lamming
With Malavika Tohani

August 2023



Thank you!

For a personal demo contact:

Klaas-Otto Ykema

Managing Director

klaas.otto.ykema@versatec.nl

+31 348 43 74 60

Tjidde Boers

CEO

tjidde.boers@viewport.ai

+31 6 5589 4628

Or visit our website at viewport.ai

